



TICA SNG LLC  
[www.tica.pro](http://www.tica.pro)



# MODULAR AIR HANDLING UNIT

## TICA CENTRAL AIR-CONDITIONING

FORM NO.B2819G01  
**TAC\TBC**





[www.ticachina.com](http://www.ticachina.com)

TICA is a hi-tech enterprise specialized in R&D, manufacturing, sales and services of air-conditioning and refrigeration products. Established in 1991, it has developed into one of the top four Chinese air-conditioning brands, with factories in Nanjing, Tianjin and Guangzhou, and a network of over 70 sales and service filiales around the world.

TICA has invested up to RMB 600 million in the first phase to build the top notch central air-conditioning R&D and production base, credited as the state enterprise R&D center. Certified by CNAS, it serves as a national R&D public service platform.

TICA produces over 30 series of products, covering AHUs, VRFs, screw chillers and centrifugal chillers, diverse enough to meet various requirements with regards to comfort and manufacturing processing application.

TICA is a strong competitor in chillers and commercial air conditioning products. It is the largest producer of AHUs in China for five consecutive years and covers over 40% of the market share as the supplier to such industries as micro-electronics, surgery operation room equipment and biopharmaceuticals.

TICA has established a global strategic joint venture with United Technologies Corporation (UTC) whose businesses include the world's most advanced Pratt & Whitney Aircraft Engines, the largest air-conditioning company Carrier and the biggest elevator company Otis.

The giant UTC transfers such global cutting-edge core technologies as large centrifugal chillers, screw chillers, and ORC systems to TICA, thrusting TICA 20 years ahead of its Chinese counterparts in terms of centrifuge technology and 30 years ahead in cryogenic power generation technology. Meanwhile, TICA and UTC will integrate global resources to create a brand-new international market pattern.

Meanwhile, the company has also provided energy-saving air-conditioning system integration solutions to both domestic and foreign users like Zhongnanhai, the Great Hall of the People, Beijing Bird's Nest stadium, the Water Cube, the Wukesong Indoor Stadium, Petro China, Sinopec, State Grid, Nanjing Panda, Hangzhou Xiaoshan Airport, Hainan Airlines Group, Shangri-La Hotel, Manila Ocean Park, Abu Dhabi Al Muneera, SM City in Philippines and Unilever, etc.



Nanjing Headquarter



Tianjin Base



Guangzhou Base

## DIRECTORY

Features	2
Nomenclature	3
Method To Determine The Side Of Unit	3
Air Flow Chart	4
Functional Sections Specifications	5
Length Of Functional Sections	7
Functional Sections Description	8
Cooling Coil Performance Chart	17
Heating Coil Performance Chart	18
Weight - Fan, Motor and Accessories	19
Unit Weight (Cabinet Only)	20
Unit Weight (Components Only)	21
Applications	22
Installation	23
Precautions For Installation And Use	24
Maintenance And Service	27

# Features

**Patented structure, low air leakage rate**



TICA patented design of labyrinth seal structure which provides low air leakage formed by using aluminum sections with concave and convex chamfer at joints of AHU body and tightening with bolts and nuts.

**Robust structural design**

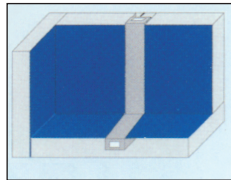

TICA labyrinth AHU has an aluminum alloy frame and a hidden metal inner frame, in which the former constitutes a rigid body with high resistance to torsion by using a tenon structure and tightening with bolts and nuts, while the latter greatly improves the strength of the unit.

**Flat interior, applicable for purification applications**



TICA labyrinth AHU is flat interiorly and has no insulation strips, seals and small cumbersome parts, making it ideal for purifying air conditioning and IAQ. The inner panel can be of hot dip galvanized panel, color panel or stainless steel panel.

**Prevention of cold bridge and rust**

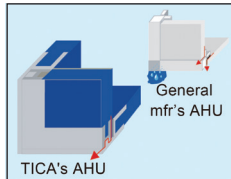

All metals inside TICA labyrinth AHU are isolated from those outside by means of polyurethane foaming and specially designed seals, eliminating insulation strips commonly used in general AHUs and therefore preventing the cold bridge. Frames of aluminum sections are embedded around all panels, completely isolating corners of metal panel from air and moisture and thereby preventing rust spot on panels.

**Leveling device**

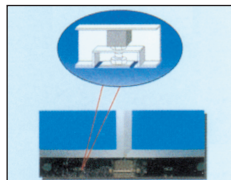

A leveling device is provided on the base, which levels individual AHU body before connecting functional sections of two AHUs, ensuring seamless connection of AHUs.

**Professional selection software**



TICA's AHUs are selected by professional selection software which is programmed in strict accordance with laws of engineering and modified according to actual service to provide more reliable software.



# Nomenclature

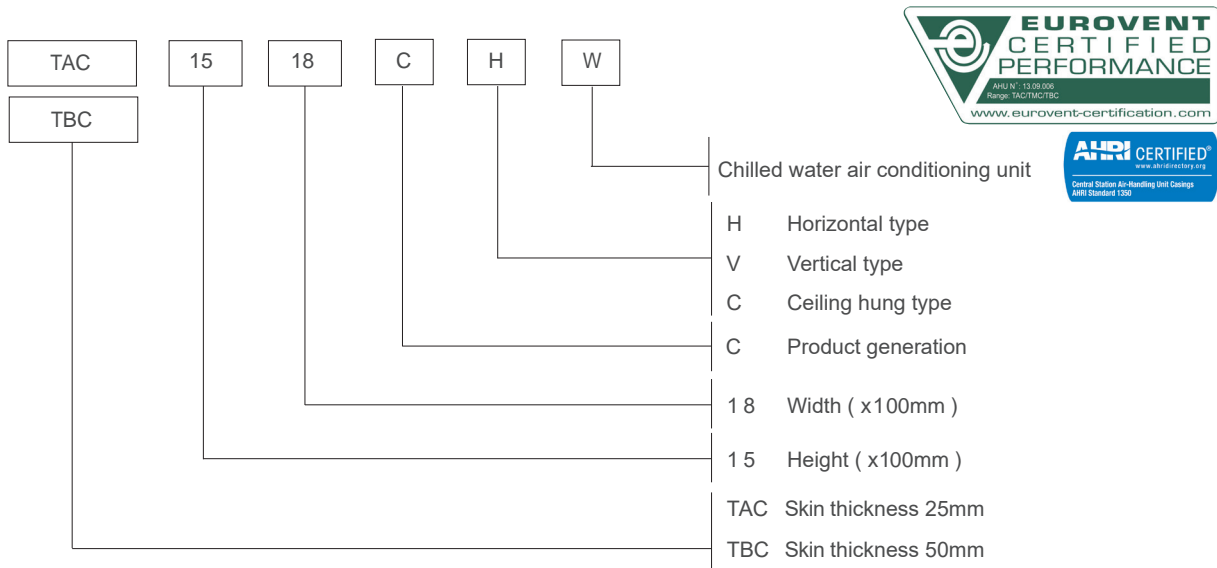

Example:

TBC 2224 CHW

Skin thickness = 50mm, Panel height = 22 x 100mm, Panel width = 24 x 100mm,

Horizontal type

Unit total height = Panel height + T + Base height      Unit total width = Panel width + T

For TAC, T = 50mm      TBC, T = 100mm

Base height = 80mm except when Panel height > 2500mm or Panel width > 2500mm

Base height = 100mm

## Method To Determine The Side Of Unit

Facing the air flow, if water piping at left side indicates left type. Otherwise, right type.

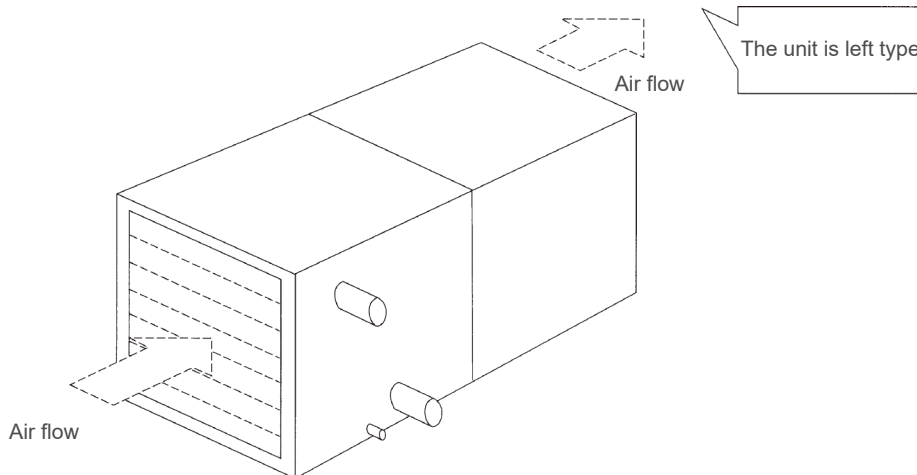







# Air Flow Chart

Unit in m<sup>3</sup>/h

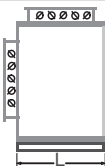
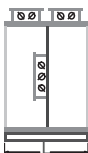

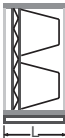
TAC/TMC/TBC		Coil Face Velocity(m/s)					
		2.00	2.25	2.50	2.80	3.00	3.50
06	07	1567	1762	1958	2193	2351	2742
06	08	1790	2014	2238	2506	2685	3133
06	09	2207	2783	2758	3089	3311	3862
06	10	2527	2843	3158	3537	3791	4422
07	10	2888	3249	3610	4043	4332	5054
07	11	3253	3660	4067	4555	4880	5693
08	10	3610	4061	4512	5053	5415	6318
08	11	4067	4575	5083	5964	6101	7117
08	12	4524	5089	5655	6334	6786	7917
08	13	4981	5604	6226	6974	7472	8717
08	14	5438	6118	6798	7614	8157	9517
10	12	5881	6616	7351	8234	8822	10292
10	13	6476	7285	8094	9066	9714	11333
10	15	7664	8622	9580	10730	11496	13412
10	16	8259	9291	10323	11562	12389	14453
11	15	8843	9949	11054	12381	13265	15475
11	16	9529	10720	11911	13341	14294	16676
11	17	10215	11492	12769	14301	15323	17876
12	17	10896	12258	13620	15254	16344	19068
12	18	11628	13081	14534	16279	17442	20349
13	17	12258	13790	15322	17161	18387	21452
13	18	13081	14716	16351	18313	19622	22892
13	19	13904	15642	17380	19465	20856	24332
14	19	14676	16511	18345	20547	22014	25683
14	20	15545	17488	19431	21763	23318	27204
15	19	16221	18249	20277	22710	24332	28387
15	21	18141	20409	22677	25398	27212	31747
16	21	19005	21381	23757	26607	28508	33259
16	22	20011	22513	25014	28016	30017	35019
16	24	22023	24776	27529	30832	33035	38540
19	22	24559	27629	30699	34383	36839	42978
19	23	25794	29018	32242	36111	38691	45140
19	25	28263	31795	35328	39568	42395	49460
20	25	29309	32973	36637	41033	43964	51291
20	26	30589	34413	38237	42825	45884	53531
21	26	32774	36871	40968	45884	49161	57355
22	27	33866	38099	42333	47412	50799	59266
23	26	36052	40558	45065	50473	54078	63091
22	30	39536	44478	49420	55351	59304	69188
25	28	42621	47949	53276	59670	63932	74587
25	31	47559	53504	59449	66582	71339	83228
25	34	52497	59059	62621	73495	78746	91870
28	34	59788	67261	74735	83703	89682	104629
28	38	67286	75697	84107	94200	100929	117751
29	40	72767	81863	90959	101874	109151	127342
31	41	79292	89204	99115	111009	118938	138761
32	45	89467	100650	111833	125253	134201	156567
35	46	101523	114213	126904	142432	152285	177665
37	50	117371	132042	146713	164319	176057	205399
38	55	136921	154037	171152	191690	205382	239612
43	58	165054	185685	206317	231075	247581	
45	65	191575	215522	239469	268205	280000	

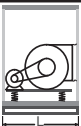
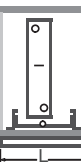
## Functional Sections Specifications

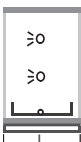
(unit in mm)

Section's Name	Symbol	Specifications (for reference only)												
Mixing Section		<table border="0"> <tr> <td>Model</td> <td>L</td> </tr> <tr> <td>0607-1117</td> <td>600</td> </tr> <tr> <td>1217-2126</td> <td>800</td> </tr> <tr> <td>2227-2534</td> <td>1000</td> </tr> <tr> <td>2834-4565</td> <td>1200</td> </tr> </table>	Model	L	0607-1117	600	1217-2126	800	2227-2534	1000	2834-4565	1200		
Model	L													
0607-1117	600													
1217-2126	800													
2227-2534	1000													
2834-4565	1200													
Fresh Air and Exhaust Air Section		<table border="0"> <tr> <td>Model</td> <td>L</td> </tr> <tr> <td>0607-1925</td> <td>1200</td> </tr> <tr> <td>2025-2940</td> <td>1500</td> </tr> <tr> <td>3141-4565</td> <td>1800</td> </tr> </table>	Model	L	0607-1925	1200	2025-2940	1500	3141-4565	1800				
Model	L													
0607-1925	1200													
2025-2940	1500													
3141-4565	1800													
Plate Filter Section		<p>L = 100mm</p> <p>Plate filter can be Pre-filter or Secondary filter, can be install inside the Mixing Section or as External Filter Section.</p>												
Bag Filter Section or Rigid Filter Section		<table border="0"> <tr> <td>Bag Filter</td> <td>L = 400</td> </tr> <tr> <td>Rigid Filter</td> <td>L = 400</td> </tr> </table>	Bag Filter	L = 400	Rigid Filter	L = 400								
Bag Filter	L = 400													
Rigid Filter	L = 400													
External Filter Section		<p>L = 100</p> <p>Install at outside of unit and will not take up space inside unit.</p>												
Fan Section		<p>L = 700 - 3500</p> <p>Details refer to Sections Length Table.</p>												
Cooling Coil Section		<table border="0"> <tr> <td>Model</td> <td>L(1R-4R)</td> <td>L(5R-6R)</td> <td>L(8R-12R)</td> </tr> <tr> <td>0607-2940</td> <td>600</td> <td>700</td> <td>900</td> </tr> <tr> <td>3141-4565</td> <td>1000</td> <td>1000</td> <td>1200</td> </tr> </table>	Model	L(1R-4R)	L(5R-6R)	L(8R-12R)	0607-2940	600	700	900	3141-4565	1000	1000	1200
Model	L(1R-4R)	L(5R-6R)	L(8R-12R)											
0607-2940	600	700	900											
3141-4565	1000	1000	1200											
Heating Coil Section		<table border="0"> <tr> <td>Model</td> <td>L(1R-2R)</td> </tr> <tr> <td>0607-2940</td> <td>300</td> </tr> <tr> <td>3141-4565</td> <td>600</td> </tr> </table> <p>For model smaller than 3141, if heating coil is located after cooling coil which is not larger than 8 rows, the heating and cooling coil can be located in L the same drain pan. Total length is 900mm.</p>	Model	L(1R-2R)	0607-2940	300	3141-4565	600						
Model	L(1R-2R)													
0607-2940	300													
3141-4565	600													
Electric Heater Section		<table border="0"> <tr> <td>T</td> <td>L</td> </tr> <tr> <td>&lt; 4</td> <td>300</td> </tr> <tr> <td>≥ 4</td> <td>700</td> </tr> </table> <p>T = Electric Power (W) / Air Flow (CMH)</p>	T	L	< 4	300	≥ 4	700						
T	L													
< 4	300													
≥ 4	700													
Steam Humidifier Section		<p>L = 600</p> <p>If it is located after Fan, L = 900.</p>												

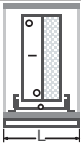
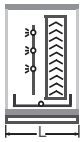
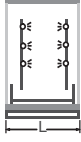
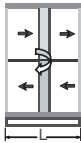
(unit in mm)

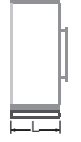
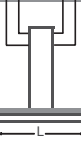
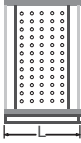
Section's Name	Symbol	Specifications (for reference only)										
Wet Film Humidifier Section		If it is installed next to Cooling Coil Section, does not need individual section length; if located in an independent section, L = 600										
High Pressure Spray Humidifier Section		L = 900 (Need moisture eliminator)										
Air Washer Humidifier Section		Double rows                      L=2100										
Heat Recovery Section		L must be determined by the actual Heat Recovery device selected.										
Diffusion Section		L = 600										
Access Door Section		L = 600 Access Door can be added before Filter Section, Cooling Coil Section, Heating Coil Section, Sound Attenuator Section, etc to ease maintenance works.										
Supply Air Section		<table border="0"> <tr> <td>Model</td> <td>L</td> </tr> <tr> <td>0607-1117</td> <td>600</td> </tr> <tr> <td>1217-2126</td> <td>800</td> </tr> <tr> <td>2227-2534</td> <td>1000</td> </tr> <tr> <td>2834-4565</td> <td>1200</td> </tr> </table>	Model	L	0607-1117	600	1217-2126	800	2227-2534	1000	2834-4565	1200
Model	L											
0607-1117	600											
1217-2126	800											
2227-2534	1000											
2834-4565	1200											
De-Humidifier Section		L must be determined by the actual De-Humidifier used.										
Sound Attenuator Section		L = 500,800,1100 for option										
	Gas Heater Section	L = 3000										
	Self-Cleaning High Efficiency Filter Section	L = 1800										
	Moisture Eliminator	Share length with cooling coil section										
	Evaporative Cooling Section	L = 900										





## Length Of Functional Sections

TAC/TMC/ TBC		Length (mm)													Others
		Mixing Box	Fresh Air and Exhaust Air	Plate Filter	Bag Filter	Rigid Filter	Cooling Coil (1R - 4R)	Cooling Coil (5R - 6R)	Cooling Coil (8R - 12R)	Heating Coil	Access	Sound Attenuator	Fan (Type A)	Fan (Type B)	
06	07	600	1200	100	400	400	600	700	900	300	600	800	900(200)	1100(225)	
06	08	600	1200	100	400	400	600	700	900	300	600	800	900(200)	1100(225)	
06	09	600	1200	100	400	400	600	700	900	300	600	800	700(200)	1200(280)	
06	10	600	1200	100	400	400	600	700	900	300	600	800	700(200)	1300(315)	
07	10	600	1200	100	400	400	600	700	900	300	600	800	700(200)	1300(315)	
07	11	600	1200	100	400	400	600	700	900	300	600	800	800(225)	1300(315)	
08	10	600	1200	100	400	400	600	700	900	300	600	800	700(200)	1300(315)	
08	11	600	1200	100	400	400	600	700	900	300	600	800	800(225)	1300(315)	
08	12	600	1200	100	400	400	600	700	900	300	600	800	800(315)		
08	13	600	1200	100	400	400	600	700	900	300	600	800	800(315)		
08	14	600	1200	100	400	400	600	700	900	300	600	800	800(315)		
10	12	600	1200	100	400	400	600	700	900	300	600	800	800(315)	1500(400)	
10	13	600	1200	100	400	400	600	700	900	300	600	800	900(335)	1500(400)	
10	15	600	1200	100	400	400	600	700	900	300	600	800	900(335)	1500(400)	
10	16	600	1200	100	400	400	600	700	900	300	600	800	900(335)	1500(400)	
11	15	600	1200	100	400	400	600	700	900	300	600	800	1000(400)	1800(500)	
11	16	600	1200	100	400	400	600	700	900	300	600	800	1000(400)	1800(500)	
11	17	600	1200	100	400	400	600	700	900	300	600	800	1100(450)	1800(500)	
12	17	800	1200	100	400	400	600	700	900	300	600	800	1100(450)		
12	18	800	1200	100	400	400	600	700	900	300	600	800	1100(450)	1200(500)	
13	17	800	1200	100	400	400	600	700	900	300	600	800	1100(450)		
13	18	800	1200	100	400	400	600	700	900	300	600	800	1100(450)	1200(500)	
13	19	800	1200	100	400	400	600	700	900	300	600	800	1100(450)	1300(560)	
14	19	800	1200	100	400	400	600	700	900	300	600	800	1200(500)	1300(560)	
14	20	800	1200	100	400	400	600	700	900	300	600	800	1200(500)	1300(560)	
15	19	800	1200	100	400	400	600	700	900	300	600	800	1200(500)	1300(560)	
15	21	800	1200	100	400	400	600	700	900	300	600	800	1300(560)	1500(630)	
16	21	800	1200	100	400	400	600	700	900	300	600	800	1300(560)	1500(630)	
16	22	800	1200	100	400	400	600	700	900	300	600	800	1300(560)	1500(630)	
16	24	800	1200	100	400	400	600	700	900	300	600	800	1300(560)	1700(710)	
19	22	800	1200	100	400	400	600	700	900	300	600	800	1500(630)	2600(800)	
19	23	800	1200	100	400	400	600	700	900	300	600	800	1500(630)	2600(800)	
19	25	800	1200	100	400	400	600	700	900	300	600	800	1700(710)	2600(800)	
20	25	800	1500	100	400	400	600	700	900	300	600	800	1700(710)	2600(800)	
20	26	800	1500	100	400	400	600	700	900	300	600	800	1800(800)	3000(900)	
21	26	800	1500	100	400	400	600	700	900	300	600	800	1800(800)	3000(900)	
22	27	1000	1500	100	400	400	600	700	900	300	600	800	2100(900)	3300(1000)	
22	30	1000	1500	100	400	400	600	700	900	300	600	800	2100(900)	3300(1000)	
23	26	1000	1500	100	400	400	600	700	900	300	600	800	1800(800)	3000(900)	
25	28	1000	1500	100	400	400	600	700	900	300	600	800	2100(900)	3300(1000)	
25	31	1000	1500	100	400	400	600	700	900	300	600	800	2100(900)	2200(1000)	
25	34	1000	1500	100	400	400	600	700	900	300	600	800	2100(900)	2200(1000)	
28	34	1200	1500	100	400	400	600	700	900	300	600	800	2100(900)	2200(1000)	
28	38	1200	1500	100	400	400	600	700	900	300	600	800	2600(800*2)		
29	40	1200	1500	100	400	400	600	700	900	300	600	800	2600(800*2)		
31	41	1200	1800	100	400	400	1000	1000	1200	600	600	800	2600(800*2)		
32	45	1200	1800	100	400	400	1000	1000	1200	600	600	800	2800(900*2)		
35	46	1200	1800	100	400	400	1000	1000	1200	600	600	800	3300(1000*2)		
37	50	1200	1800	100	400	400	1000	1000	1200	600	600	800	3300(1000*2)		
38	55	1200	1800	100	400	400	1000	1000	1200	600	600	800	3400(1120*2)		
43	58	1200	1800	100	400	400	1000	1000	1200	600	600	800	3400(1120*2)		
45	65	1200	1800	100	400	400	1000	1000	1200	600	600	800	3500(1250*2)		

Length of Heat Recovery and De-humidifier Section is based on actual selection. Gas Heater Section: 3000. Activated Carbon Section: 100-500.

Note :1. Unit total length is equal to the summation of all sections.

2. The length as listed above is for reference only. Actual dimension may vary due to actual application and design.

# Functional Sections Description

## ■ Cabinet



Cabinets consist of standard panels measuring 100mm each in length. The inter-connecting parts of panels are made of proprietary designed aluminum profiles which guarantee minimum air leakages and panels are fitted together with bolts and nuts. As a result, the panels can be assembled or dis-assembled at site without compromising the quality of assembly. The construction of panels are formed white-coated GI metal sheet (external surface), PU foam (as insulation material) and GI metal sheet (internal surface). The proprietary designed aluminum frames for panels act as built in structural supports and this is further strengthened by additional internal/hidden frames. Apart from that, the bottom panels are designed to withstand weight of service and maintenance personnel without deformation of panels. The highly integrated method of joining ensure minimum leakages, no cold bridge, minimum or no corrosion, rigid and strong. The unit and components come with hanging/hoisting holes for easier transportation and commissioning at site..

## ■ Mixing Section

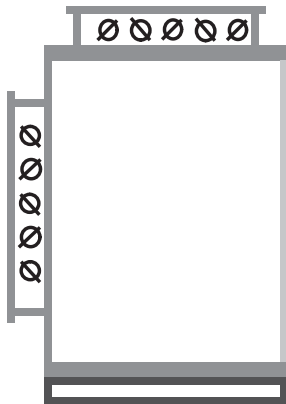

Providing chamber for mixing of return air and fresh air to modulate the ratio of air mixture. It has air dampers, which is made of GI metal vanes with aerofoil profile that can be controlled manually or with motorized control. Sizing of air dampers is based on maintaining surface velocity of 8m/s to ensure that the noise generated by the air dampers do not exceed the overall noise level of the unit. When the air dampers are installed above the unit, the section length will determine the height of the dampers and Max. Height Of Damper = Section Length - 160mm

## ■ Filters Section

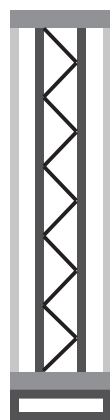

Plate Filter

Filters' quality, air resistance, anti-static properties, moisture absorption ability, fire retardancy and filtration efficiency are complied to GB/T 14295-93 standard. The cross sectional air speed for entering air is uniform and greater than 80% of the nominal air speed of the unit.

Classification of filters:

- Primary :

Plate and Bag type; Made of synthetic fiber and non-woven cloth

- Secondary :

Plate, Bag and Rigid type; Made of synthetic fiber and fiber glass

- Sub-HEPA :

Bag and Rigid type; Made of fine fiber glass

- HEPA :

Rigid and Box type; Made of fiber glass

- Active Carbon Filter :

Used to remove bad odor and pollution from air. Normal filters are required to be installed before and after Active Carbon Filter to prolong the lifespan of filter and to prevent loose carbon particles from entering the air stream.

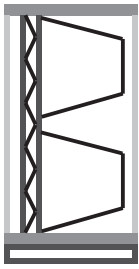

Bag Filter or Rigid Filter

Note: Depending on user needs

1. Optional - nylon filter (built-in type is not recommended), multi-layer metal filter.
2. Panel filters and bag filters have equal filtering sectional area but different thickness which is 46 mm and 381 mm, respectively.
3. External filters are drawable from the side, while built-in filters are from the front.
4. Installation of built-in filters can be slide-way or frame style: generally, the former type is for applications requiring comfort while the latter for purification applications.

### Air Flow Resistance Charts ( For Reference Only )

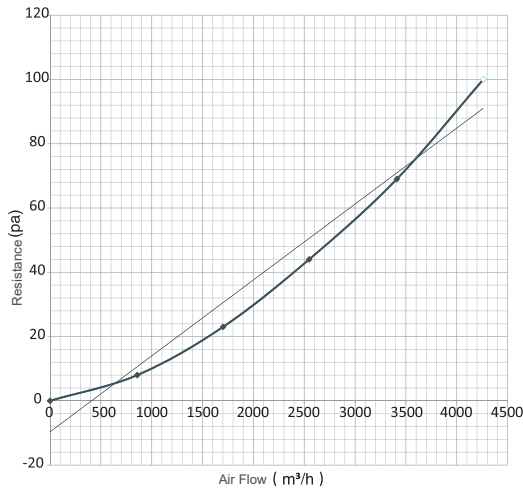

G4 Plate Filter ( 24''\*24'' )

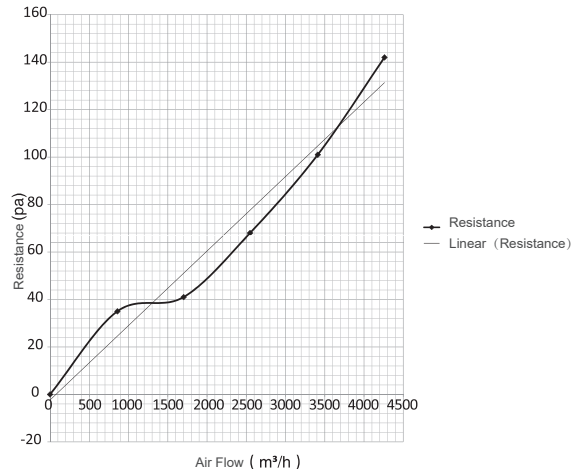

F7 Bag Filter ( 24''\*24'' )

### Filter Classification Comparison Table

China-GB/ T14295	Pre Filter $\geq 5\mu m$ 80% > Efficiency $\geq 20\%$					Secondary Filter $\geq 1\mu m$ 70% > Efficiency $\geq 20\%$					High Efficiency Filter $\geq 1\mu m$ 99% > Efficiency $\geq 70\%$				Secondary HEPA Filter $\geq 0.5\mu m$ 99.9% > Efficiency $\geq 95\%$				HEPA Filter $\geq 0.5\mu m$ Efficiency $\geq 99.99\%$			
U.S. - ASHRAE	C1	C2-C4	L5	L6	L7	L8	M9	M10	M11	M12	M13	M14	H12-H16				VH17	VH18	VH19	VH20		
Europe - New Standard	G1	G2	G3	G4		F5	F5	F5	F7	F8	F8	F9	H10	H11	H12	H13	H14	U15-U17				
Europe - Old Standard	EU1	EU2	EU3	EU4		EU5	EU6	EU6	EU7	EU8	EU8	EU9	EU10	EU11	EU12	EU13	EU14					
	65%	80%	80%-90%		> 90%	40%	60%	80%	90%	85%	95%	95%	99.90%	99.95%	99.995%	99.9995%						

### Filter Size and Quantity

Model	0607	0608	0609	0610	0710	0711	0810	0811	0812	0813	0814	1012	1013	1015	1016	1115	1116	1117	1217
Filter Size 24''*24''												1	2	2	2				2
Filter Size 24''*20''									1			1				4	4	4	2

Model	1218	1317	1318	1319	1419	1420	1519	1521	1621	1622	1624	1922	1923	1925	2025	2026	2126	2227	2230
Filter Size 24''*24''	2	4	4	6	6	6	6	6	6	6	6	9	9	12	12	12	12		12
Filter Size 24''*20''	3																	12	

Model	2326	2528	2531	2534	2834	2838	2940	3141	3245	3546	3750	3855	4358	4565
Filter Size 24''*24''	12	16	20	20	20	24	24	30	35	35	42	48	63	70
Filter Size 24''*20''														

Note:

1. Table above is only applicable to Plate and Bag Filter.

2. Plate Filter

Nominal Size	Actual Size (Length*Width*Thickness,mm)
24''*24''	595*595*46
24''*20''	595*493*46

3. Bag Filter

Nominal Size	Actual Size (Length*Width*Thickness,mm)
24''*24''	592*592*381
24''*20''	592*490*381

## Coil Section

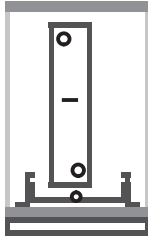

Cooling Coil

Cooling and Heating coils are made of aluminum fins and copper tubes with Copper tubes are mechanically expanded and securely bonded to aluminum fins. Aluminum fins ranging from 8 - 14 fins/inch. The coils are designed for easy maintenance in mind and they can be easily slid out for service and maintenance works. The headers of coil are made of steel with an air vent at the top and also a water release port at the bottom. Coil's cross sectional air speed is greater than 80% of nominal air speed. All coils have been leak tested with 2.4MPa pressure and the recommended maximum operating pressure is 1.6MPa. All water pipes and condensing water pipes are located at the same side of the unit. Optional moisture eliminator can be installed to prevent water carrying over even at high air velocity. The drain pan is made of insulated steel plate and galvanized steel pipes as condensate water discharge pipe.

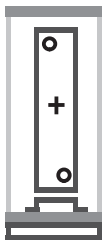

Heating Coil

Warning: Make sure that steam valve is shut off before the fan stops.

The steam coil must be furnished with a steam trap as specified in the operation manual.

Note: Depending on user needs

1. The fin can be of copper or hydrophilic aluminum foil.
2. Both the terminal plate and drain pan shall be of stainless steel.
3. Stainless steel header or galvanized steel header can be used for coils.

## Fan Section

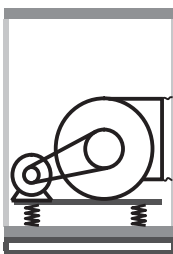

Centrifugal Fan

Base on the requirements of air flow rate and external static pressure, the selection software able to select one or multiple centrifugal fan. Various type of fan blades design can be chosen based on different application needs, i.e. Forward Curved, Backward Curved and Aerofoil.

Fans are statically and dynamically balanced and are driven by multiple anti-static V-belts. Bearings are of seal type and there is no lubrication required for the whole operating life of bearings. All the blower housing and frames are made of GI steel.

Fan motors are of totally closed enclosure type, with single speed and 4 poles in general. Base bracket/frame of fan motor is adjustable and together with fan blower, they are sitting on a structure that equipped with vibration isolator (with noise damper and adjusting rod).

The fan outlet is connected to AHU body with flexible connectors, and the fan section has an access door or may have a readily removable access panel that allow the fan and motor to be completely pulled out of the unit.

Note: Depending on user needs

1. The fan can be of voluteless, aerofoil, direct driven or single-inlet type;
2. The fan can be equipped with single-speed 2/4/6-pole, double-speed, three-speed and variable frequency motor.



### Fan Outlet Direction

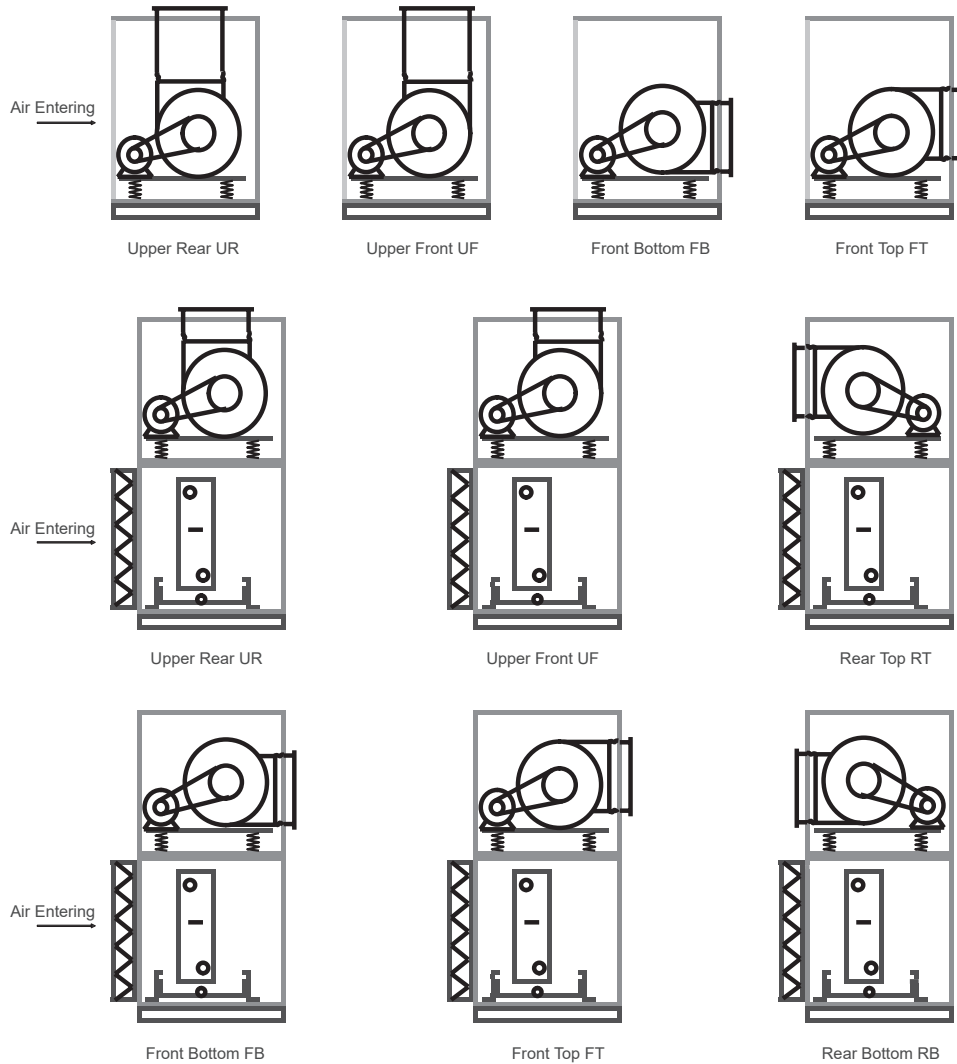

### Humidifying Section

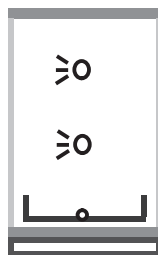

Steam Humidifier

There are a few types of humidifier:

- a. Dry steam humidifier - Isotherm humidifier, made of stainless steel and with properties of high corrosion resistance, small size, easy installation, clean humidification and high efficiency. There are 2 types of dry steam humidifier, i.e. electric driven or manual. Applicable for sites with steam source.
- b. Electrode humidifier - Generate steam from water through application of AC current. It is microcomputer controlled with modulating control or ON/OFF control. Applicable for industrial sites without steam source.

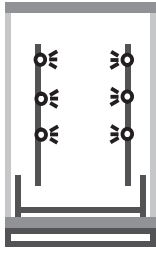

Air Washer Humidifier

c. Air washer humidifier can achieve various air treatment simultaneously. It is able to reduce the enthalpy, humidity and temperature of air and at the same time form an water curtain across the air stream to clean the air.

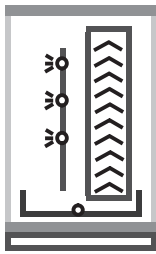

High Pressure Spray Humidifier

d. High pressure spray humidifier - pressurized the water and inject through nozzle to create mist and humidify the air through evaporation of the mist. The efficiency is about 40 ~ 50%

## ■ Electric Heater Section



The electric heating element is fixed on the frame.

The power supply can be 380V 3N ~ 50Hz.

The control cabinet is installed by users.

2/multiple-stage control connection meets different needs for heating power control.

Warning:

1. Make sure that the fan is started before electric heater is activated.
2. Turn off the electric heater 5 min before the fan stops.
3. The electric heater overheat switch shall be connected to the electric heating control circuit.
4. SCR cannot be used for PTC electric heating to avoid impairing safety and affecting temperature accuracy.

## ■ Sound Attenuator Section

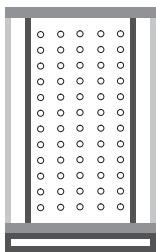

Under different application requirements and noise characteristics of fan, 2 types of Sound Attenuators can be installed, i.e. Sound Absorption Medium Plate Muffler or a Micro-Perforated Plate Muffler. Sound Absorption Medium Plate Muffler is made of perforated panel filled with noise absorbing material. It has good sound attenuation effect towards high and medium frequency noise. Micro-Perforated Plate Muffler is made of micro-perforated panel which applying principles of resonance for sound attenuation. It has good filtering effect for low and medium frequency noise. Since it does not require sound absorbing medium, it is non-polluting and not affected by moisture. Sound attenuator can be classified as Return Air Sound Attenuator and Supply Air Sound Attenuator.

### Heat Recovery Section

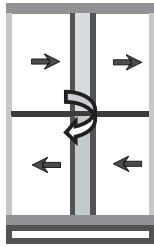

Heat Recovery Wheel

There are a few types of Heat Recovery devices:

- a. Heat wheel - for both sensible and latent heat recovery with the efficiency of 70~90%. The counter flow between fresh air and exhaust air offers self-cleaning capability.
- b. Run around coil heat exchanger - the media used can be water or glycol solution and can be applied for small temperature difference system. The efficiency is lower than 60%.
- c. Counter flow plate heat exchanger - fresh air and exhaust air exchange the energy in the plate type heat exchanger and depends on the material used for heat exchanger, the heat transferred can be sensible only or total heat. The efficiency is about 50%, however, due to no physical contact of fresh air and exhaust air, there is no pollution of fresh air by the exhaust air.
- d. Heat pipe heat exchanger - each pipe contains Freon or ammonia as the working fluid and the heat recovery is done through phase change of working fluid with no moving parts involve.

### Self-Cleaning High Efficiency Filter Section

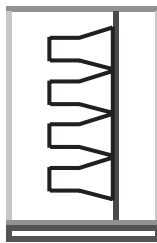

Self-Cleaning High Efficiency Filter has high capacity for dust collection. When the dust has been accumulated, service personnel can remove the dust by blowing with compressed air and the dust will be collected at the metal pan at the bottom. This will eliminate the needs to change the filter frequently.

### Gas Heater Section

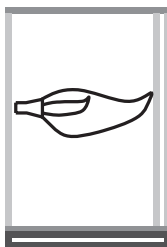

There are two methods of heating, one is to burn the gas directly inside the plenum to heat the air stream and it is suitable for huge conditions space. Second is to heat the air at the burner outside the unit and channel the hot air through tubes which are running within the air stream. This will avoid consuming the oxygen in the air stream and maintain the supply air quality.

### Evaporative Cooling Section

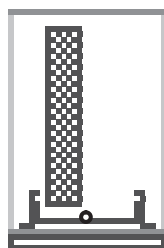

Evaporative Cooling

Spraying water on evaporative material which achieve cooling through evaporation of water. No refrigerant is needed and the operating cost is low.

## ■ Wholesome Sterilization Unit

### Electronic Purification Section

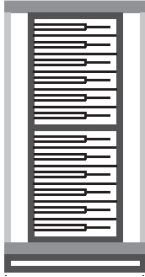

#### Dust removal and purification

It ionizes suspended particles in the air through electric field by applying positive charge to all suspended particles (0.01  $\mu\text{m}$  minimum) via high-voltage electrostatic field (HVEF), and then rapidly absorbing them by dust-collecting plate for efficient dust removal and purification. The one-time efficiency of duct collection is above 98.9%.

#### Sterilization and purification

Under high voltage, the discharge electrode produces plasma which rapidly disrupts cell nucleus of microorganism in the air such as bacteria, virus and dust mite and kill them; then residual matters are sintered and absorbed by the dust-collecting plate to provide sterilization rate up to above 99%. It prevents propagation of bacteria, virus and infectious disease viruses in the central air conditioning system and therefore eliminates cross infection. The one-time sterilization efficiency is above 94.69%.

### Activated Carbon Adsorption Section

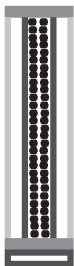

#### Super odor absorption and removal

The functional section has a built-in activated carbon filter. Activated carbon is fine carbon granules, which has large surface area and finer pores in granules – capillary. The capillary has strong adsorption capacity, and the large surface area of granules allows full contact with gases (impurities). When reaching the capillary surface, gases (impurities) are absorbed for purification.

### Absorption of formaldehyde, benzene, TVOC and other harmful gases

Type of Activated Carbon	N4G1	N4S1	N4A1	N4B1	N4F1	N4M1
Purpose	General gas	Stink	Acid gas	Base gas	Formaldehyde	Mercury vapor



## Photocatalyst Sterilization And Purification Section

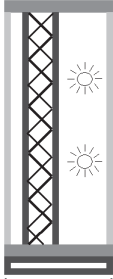

### Sterilization, removal of odor and formaldehyde

The photocatalyst is a generic term of semiconductor materials with photo-catalysis and represented by nano-sized  $TiO_2$ . Under special wavelength of ultraviolet radiation, photocatalyst produces free hydroxyl and reactive oxygen with strong oxidation capacity which can rupture membranes of cells and proteins of viruses, and decompose organic pollutants (formaldehyde, benzene etc.).

## UV Lamp



### Ultraviolet sterilization and disinfection

Ultraviolet sterilization is to destroy and change the NDA structure of microorganism through ultraviolet radiation so as to kill bacteria immediately or make them unable to reproduce for disinfection effect. It is UVC that really has disinfection effect, because C frequency-range ultraviolet is easily absorbed by NDA of organism, especially those of 253.7 nm. Ultraviolet sterilization belongs to pure physical disinfection, which is convenient, fast, and easy to manage and achieve automation with broad spectrum and high effect, without secondary pollution.

## Ozone Generator

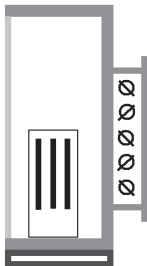

### Ozone sterilization and disinfection

Ozone ( $O_3$ ) is easily decomposed into oxygen ( $O_2$ ) and single oxygen atoms at room temperature. Oxygen atoms have strong oxidation and can oxidize and decompose enzyme needed in bacteria, or directly interact with bacteria, viruses to destroy their cells and decompose cell DNA so as to kill cells, obligate parasites, virion by dissolution.

The ozone generator produces ozone by means of gas ionization discharge, and regularly sterilizes and disinfects the space controlled by the system for purification without any residual matters harmful to human health compared to chemical disinfectants.

## Comparision of purification and sterilization technologies

Sterilization Method	Ability of Dust Removal	Ability of Killing Bacteria and Viruses	Ability of Removing Formaldehyde, Benzene and TVOC
Electronic purification	☆	☆	
Activated carbon			☆
Ultraviolet lamp		☆	
Photocatalyst		☆	
Ozone generator		☆	
Traditional plate/bag filter	☆		

– strong, space - without

## Comparision of purification and sterilization technologies in installation and maintenance

1M=100mm

Sterilization Method	Length of Functional Section	Power Supply	Replacement and Cleaning
Electronic purification	3M	220 V ~ 50 Hz	Cleaning once a year
Activated carbon	Plate: 1M, carbon box: 4M	220 V ~ 50 Hz	Plate: unwashable, carbon box: addition of carbon allowed
Ultraviolet lamp	0M, not occupying the section length	220 V ~ 50 Hz	No need for cleaning, continuous use
Photocatalyst	3M	220 V ~ 50 Hz	No need for cleaning, continuous use
Ozone generator	0M, located at air outlet section	220 V ~ 50 Hz	Cleaning once half a year
Traditional plate/bag filter	1M, 5M		Consumable



## Cooling Coil Performance Chart

TAC/TMC/TBC		Air Flow m <sup>3</sup> /h	Fresh Air Condition						Return Air Condition					
			4 Rows		6 Rows		8 Rows		4 Rows		6 Rows		8 Rows	
			SC kW	TC kW	SC kW	TC kW	SC kW	TC kW	SC kW	TC kW	SC kW	TC kW	SC kW	TC kW
06	07	1958	9	21	12	29	13	31	8	9	9	12	10	15
06	08	2238	11	24	14	33	15	36	9	11	10	14	11	17
06	09	2758	13	29	17	41	18	44	11	13	12	17	14	21
06	10	3158	15	33	19	46	21	50	12	15	14	19	16	24
07	10	3610	17	38	22	53	24	58	14	17	16	22	18	28
07	11	4067	19	43	25	60	27	65	16	20	18	25	21	31
08	10	4512	21	47	28	66	30	72	18	22	20	27	23	35
08	11	5083	24	53	31	75	34	81	20	24	22	31	26	39
08	12	5655	27	59	35	83	37	90	22	27	25	34	29	43
08	13	6226	29	66	38	92	41	99	24	30	27	38	31	48
08	14	6798	32	72	42	100	45	108	27	33	30	41	34	52
10	12	7351	35	77	45	108	49	117	29	35	32	45	37	56
10	13	8094	38	85	50	119	53	129	32	39	36	49	41	62
10	15	9580	45	101	59	141	63	153	37	46	42	58	48	73
10	16	10323	49	109	63	152	68	165	40	50	45	63	52	79
11	15	11054	52	116	68	163	73	176	43	53	49	67	56	85
11	16	11911	56	125	73	175	79	190	46	57	52	72	60	91
11	17	12769	60	134	78	188	84	204	50	61	56	78	54	98
12	17	13620	64	143	84	200	90	217	53	65	60	83	69	104
12	18	14534	69	153	89	214	96	232	57	70	64	88	73	111
13	17	15322	72	161	94	225	101	244	60	74	67	93	77	118
13	18	16351	77	172	100	241	108	261	64	79	72	99	82	125
13	19	17380	82	183	107	256	115	277	68	83	76	106	88	133
14	19	18345	87	193	113	270	121	293	72	88	81	111	93	141
14	20	19431	92	204	119	286	128	310	76	93	85	118	98	149
15	19	20277	96	213	124	298	134	324	79	97	89	123	102	156
15	21	22677	107	239	139	334	150	362	89	109	100	138	114	174
16	21	23757	112	250	146	350	157	379	93	114	104	144	120	182
16	22	25014	118	263	153	368	165	399	98	120	110	152	126	192
16	24	27529	130	290	169	405	182	439	107	132	121	167	139	211
19	22	30699	145	323	188	452	203	490	120	147	135	186	155	235
19	23	32242	152	339	198	474	213	514	126	155	142	196	163	247
19	25	35328	167	372	217	520	233	564	138	170	155	215	178	271
20	25	36637	173	385	225	539	242	585	143	176	161	222	185	281
20	26	38237	180	402	234	563	252	610	149	184	168	232	193	293
21	26	40968	193	431	251	603	270	654	160	197	180	249	207	314
22	27	42333	199	445	259	623	279	676	165	204	186	257	214	324
23	26	45065	212	474	276	663	297	719	176	216	198	274	227	346
22	30	49420	233	520	303	727	326	789	193	238	217	300	250	379
25	28	53276	251	560	327	784	352	850	208	256	234	324	269	409
25	31	59449	280	625	365	875	392	948	232	285	261	361	300	456
25	34	62621	309	690	402	965	433	1047	256	315	288	398	331	503
28	34	74735	352	786	458	1100	493	1192	292	359	328	454	377	573
28	38	84107	397	885	516	1237	555	1342	328	404	370	511	424	645
29	40	90959	429	957	558	1338	600	1451	355	437	400	552	459	698
31	41	99115	467	1043	608	1458	654	1581	387	476	435	602	500	760
32	45	111833	527	1177	686	1645	738	1784	436	537	491	679	564	858
35	46	126904	598	1335	778	1867	838	2025	495	609	558	771	640	973
37	50	146713	692	1543	900	2158	968	2341	573	705	645	891	740	1125
38	55	171152	807	1801	1050	2518	1130	2731	668	822	752	1039	863	1313
43	58	206317	973	2171	1265	3035	1362	3292	805	991	906	1253	1040	1582
45	65	239469	1129	2519	1468	3523	1581	3821	935	1150	1052	1454	1207	1837

Note:

- 1.Fresh Air Condition: entering air temperature 35°CDB/28°CWB.
- 2.Return Air Condition: entering air temperature 27°CDB/19.5°CWB.
- 3.Chilled water entering/leaving temperature. 7°C/12°C.Coil face velocity is 2.5m/s.
- 4.Manufacturer reserves the rights to change the data without prior notice.
- 5.Abbreviations:SC - Sensible Cooling Capacity,TC - Total Cooling Capacity.

# Heating Coil Performance Chart

TAC/TMC/TBC		Air Flow m <sup>3</sup> /h	Fresh Air Condition				Return Air Condition			
			1Rows TH kW	2Rows TH kW	3Rows TH kW	4Rows TH kW	1Rows TH kW	2Rows TH kW	3Rows TH kW	4Rows TH kW
06	07	1958	12	18	23	26	9	14	19	21
06	08	2238	14	20	26	30	10	16	21	24
06	09	2758	17	25	32	37	12	20	26	30
06	10	3158	20	29	37	42	14	23	30	34
07	10	3610	23	33	42	48	16	26	34	39
07	11	4067	26	37	47	54	18	29	39	44
08	10	4512	28	41	52	60	20	32	43	49
08	11	5083	32	46	59	68	23	36	49	55
08	12	5655	36	52	65	75	25	41	54	62
08	13	6226	39	57	72	83	28	45	59	68
08	14	6798	43	62	79	91	30	49	65	74
10	12	7351	46	68	85	98	33	53	70	80
10	13	8094	51	74	94	108	36	58	77	88
10	15	9580	60	87	111	128	42	69	91	105
10	16	10323	65	94	120	138	46	74	99	113
11	15	11054	70	101	128	147	49	79	106	121
11	16	11911	75	109	138	159	53	85	114	130
11	17	12769	81	116	148	170	57	91	122	139
12	17	13620	86	124	158	182	60	98	130	149
12	18	14534	92	133	168	194	64	104	139	159
13	17	15322	97	140	177	204	68	110	146	167
13	18	16351	103	149	189	218	72	117	156	178
13	19	17380	110	158	201	232	77	124	166	190
14	19	18345	116	167	212	245	81	131	175	200
14	20	19431	123	177	225	259	86	139	186	212
15	19	20277	128	185	235	270	90	145	194	221
15	21	22677	143	207	263	302	100	162	217	247
16	21	23757	150	217	275	317	105	170	227	259
16	22	25014	158	228	290	334	111	179	239	273
16	24	27529	174	251	319	367	122	197	263	300
19	22	30699	194	280	355	409	136	220	293	335
19	23	32242	204	294	373	430	143	231	308	352
19	25	35328	223	322	409	471	157	253	337	386
20	25	36637	231	334	424	488	162	262	350	400
20	26	38237	241	349	443	510	169	274	365	417
21	26	40968	259	374	474	546	182	293	391	447
22	27	42333	268	389	497	562	184	303	399	454
23	26	45065	284	411	522	601	200	323	430	492
22	30	49420	313	454	581	656	215	353	466	530
25	28	53276	336	486	617	710	236	382	509	581
25	31	59449	375	542	688	793	263	426	568	649
25	34	62621	414	598	760	875	291	470	627	716
28	34	74735	472	682	865	996	331	535	714	816
28	38	84107	531	767	974	1121	373	602	803	918
29	40	90959	574	829	1053	1213	403	652	869	993
31	41	99115	626	904	1148	1322	439	710	947	1082
32	45	111833	706	1020	1295	1491	496	801	1068	1220
35	46	126904	801	1157	1469	1692	562	909	1212	1385
37	50	146713	926	1338	1699	1956	650	1051	1401	1601
38	55	171152	1080	1561	1982	2282	758	1226	1635	1868
43	58	206317	1302	1881	2389	2751	914	1478	1970	2251
45	65	239469	1512	2184	2773	3193	1061	1715	2287	2613

Note:

- 1.Fresh Air Condition: entering air temperature 7°CDB.
- 2.Return Air Condition: entering air temperature 15°CDB.
- 3.Hot water entering/leaving temperature,60°C/50°C.Coil face velocity is 2.5m/s.
- 4.Manufacturer reserves the rights to change the data without prior notice.
- 5.Abbreviations:TH - Total Heating Capacity.



## Weight - Fan, Motor and Accessories

Fan Model	Forward Curve	Backward Curve	Fan and Motor Installation Base Frame Weight
	kg	kg	kg
180	10	/	17.4
200	11	/	18
225	13	/	18.6
250	22	23	19.2
280	25	26	19.8
315	31	32	21.6
355	41	44	22.8
400	53	59	25
450	67	74	28
500	77	84	30
560	126	138	86
630	176	177	100
710	220	253	109
800	289	326	124
900	384	427	180
1000	450	518	204

Motor Power	Motor Weight	Motor Accessories Weight
kW	kg	kg
0.55	16	3
0.75	17	3
1.1	21	4
1.5	25	5
2.2	32	7
3	36	8
4	45	14
5.5	60	20
7.5	73	23
11	116	35
15	137	42
18.5	170	56
22	186	63
30	254	84
37	308	107
45	335	124
55	450	135
75	534	163

## Unit Weight (Cabinet Only)

TAC/TMC/TBC		Weight (kg)														
		Thickness25mm					Thickness35mm					Thickness50mm				
		Terminal Panel	300	600	900	1200	Terminal Panel	300	600	900	1200	Terminal Panel	300	600	900	1200
06	07	5	38	68	86	99	6	40	70	90	104	7	41	73	99	111
06	08	6	40	70	88	101	7	42	72	93	107	8	43	75	102	116
06	09	7	42	72	97	111	8	44	74	101	116	9	45	77	104	126
06	10	8	44	74	102	117	9	46	75	106	122	10	47	79	106	132
07	10	8	45	75	104	119	9	47	77	107	124	10	48	81	110	134
07	11	9	47	77	107	123	9	49	79	109	126	10	50	83	112	138
08	10	10	46	76	105	121	11	48	78	108	125	12	49	82	112	136
08	11	10	48	78	108	124	11	50	80	110	127	12	51	84	114	139
08	12	10	50	80	110	127	11	52	82	112	132	12	53	86	116	142
08	13	11	52	82	112	132	12	54	84	114	139	13	55	88	118	145
08	14	12	54	84	114	135	13	56	86	116	143	14	57	90	120	148
10	12	12	52	82	111	131	13	53	84	113	142	14	55	87	118	146
10	13	13	54	84	113	136	14	55	86	115	145	15	57	89	119	149
10	15	15	58	88	117	143	16	59	90	119	150	17	61	93	123	155
10	16	16	60	90	119	146	17	61	92	122	152	18	63	95	125	158
11	15	17	59	89	118	146	18	60	91	121	150	19	62	94	124	156
11	16	18	61	91	120	149	19	62	93	123	153	20	64	96	126	159
11	17	19	63	93	122	152	21	64	95	125	156	22	66	98	129	162
12	17	20	64	94	124	154	22	65	96	127	158	23	67	99	131	164
12	18	21	66	96	126	156	23	67	98	129	160	24	69	101	133	166
13	17	22	65	95	124	154	23	66	97	127	158	24	68	100	131	164
13	18	24	67	97	126	156	25	68	99	129	160	25	70	102	133	166
13	19	25	69	99	128	158	26	70	101	131	162	27	72	104	135	168
14	19	25	70	100	131	160	26	71	102	132	164	27	73	105	137	172
14	20	27	72	102	134	162	28	73	104	136	166	29	75	107	139	176
15	19	27	71	101	133	161	28	72	103	135	168	29	74	106	138	175
15	21	31	75	105	140	165	32	78	109	142	178	33	78	110	144	185
16	21	33	77	107	144	168	34	80	111	146	183	35	80	112	148	190
16	22	34	79	109	149	172	36	82	114	150	188	37	82	115	154	196
16	24	37	85	123	160	197	40	86	127	165	204	43	88	131	172	213
19	22	41	84	122	161	200	44	85	126	166	206	48	87	130	172	215
19	23	42	86	124	163	202	45	87	128	168	208	50	89	132	174	217
19	25	44	90	128	168	206	47	91	132	172	212	52	93	136	178	221
20	25	49	93	134	175	216	52	95	138	180	222	56	97	142	187	231
20	26	50	95	136	177	218	53	97	140	182	224	58	99	144	189	233
21	26	53	96	139	182	225	56	98	142	187	231	60	100	147	193	240
22	27	57	98	141	184	227	61	100	144	189	234	72	102	149	196	243
23	26	57	100	143	186	229	61	102	146	191	236	72	104	151	198	245
22	30	63	110	158	205	253	67	113	161	211	260	79	115	167	219	270
25	28	66	124	182	240	297	69	126	186	245	305	80	128	191	253	315
25	31	72	133	193	253	312	72	135	197	258	320	87	138	202	266	331
25	34	79	142	203	265	327	84	144	208	272	335	94	147	213	280	347
28	34	91	147	213	279	345	98	149	213	279	345	109	156	224	295	366
28	38	102	158	226	294	362	107	160	230	301	371	128	163	237	311	384
29	40	104	162	230	298	362	109	164	234	305	375	130	167	241	315	388
31	41	121	171	244	318	391	135	173	250	326	402	153	165	257	337	417
32	45	132	181	257	332	408	148	184	263	341	419	166	188	270	352	434
35	46	150	192	276	360	444	163	195	282	369	455	182	199	289	381	472
37	50	163	206	292	378	464	174	209	298	387	477	206	213	306	400	493
38	55	197	222	313	404	494	208	226	320	414	507	223	231	329	427	525
43	58	235	249	343	439	534	247	252	348	444	547	266	258	359	462	570
45	65	274	279	375	479	585	289	282	379	484	597	311	288	398	512	633

Example of weight calculation:

- 1.Total Weight of Cooling Coil Section = Cooling Section Cabinet Weight + Coils Weight
- 2.Total Weight of Fan Section = Fan Section Cabinet Weight + Fan Weight + Motor Weight + Motor Accessories Weight + Fan and Motor Base Frame Weight
- 3.Total Unit Weight = Sum of Weight for each Section + Panel Weight



## Unit Weight (Components Only)

TAC/TMC/TBC		Weight (kg)																	
		Dampers - Mixing Box	Panel Filter	Bag Filter	Moisture Eliminator	Sound Attenuator	Wet Film Humidifier (Dry)				Standard 1/2" Coil (Without Water)								
							Thickness 50mm	Thickness 100mm	Thickness 150mm	Thickness 200mm	1 Rows	2 Rows	3 Rows	4 Rows	5 Rows	6 Rows	8 Rows	10 Rows	12 Rows
06	07	11	4	4	5	15	7	8	10	11	15	19	21	23	25	28	32	37	41
06	08	11	5	5	6	18	7	9	10	11	17	22	23	25	28	31	36	41	46
06	09	15	5	5	7	20	8	9	11	13	17	22	24	26	30	33	39	45	50
06	10	18	6	6	8	22	8	10	11	13	17	23	26	28	32	36	43	49	55
07	10	18	6	7	10	26	8	10	12	14	19	26	29	32	36	40	47	54	61
07	11	20	7	8	11	28	8	10	12	15	20	27	30	34	38	43	51	59	66
08	10	18	7	8	12	29	9	11	13	15	23	31	34	38	43	48	57	66	74
08	11	20	8	9	14	32	9	11	13	16	24	32	36	40	46	52	62	71	80
08	12	22	9	10	15	35	9	12	14	17	25	34	38	43	49	55	66	76	86
08	13	24	10	10	17	38	9	12	15	17	26	36	40	45	52	59	70	81	92
08	14	26	10	11	19	41	10	12	15	18	27	37	42	48	55	62	75	86	98
10	12	22	11	12	20	44	10	12	15	18	31	42	48	53	61	69	83	96	108
10	13	24	12	13	22	48	10	13	16	19	32	44	50	56	65	73	88	102	116
10	15	29	14	15	26	55	11	14	17	21	34	47	55	62	72	81	99	115	131
10	16	31	15	16	28	59	11	14	18	22	35	49	57	65	75	86	104	121	139
11	15	29	15	17	30	61	11	15	18	22	38	53	62	70	81	92	112	130	149
11	16	31	16	18	33	65	11	15	19	23	39	55	64	73	85	97	118	138	158
11	17	33	17	19	35	69	12	16	20	24	40	57	67	76	89	101	124	145	166
12	17	48	19	21	37	75	12	16	20	25	43	60	71	81	94	107	131	154	176
12	18	51	20	22	40	79	12	17	21	26	44	62	73	84	98	112	137	161	185
13	17	48	20	22	42	81	12	17	21	26	47	66	78	89	104	119	145	171	196
13	18	51	22	24	45	86	13	17	22	27	48	69	81	93	109	124	152	179	206
13	19	54	23	25	48	91	13	18	23	28	49	71	84	97	113	130	159	188	216
14	19	54	25	27	51	98	13	18	24	29	52	74	88	102	119	136	167	197	227
14	20	58	26	28	54	103	14	19	24	30	53	76	91	105	124	142	174	206	238
15	19	54	26	29	56	105	14	19	25	31	56	81	96	111	130	149	183	216	249
15	21	61	29	32	63	116	14	20	26	33	59	86	102	119	140	161	199	235	272
16	21	61	31	34	66	123	15	21	27	34	61	89	107	124	146	168	207	246	284
16	22	64	33	35	69	129	15	21	28	35	63	92	110	129	151	174	215	256	296
16	24	70	36	39	77	141	16	23	30	37	66	97	117	138	162	187	232	276	320
19	22	64	39	42	85	153	16	24	31	39	75	109	132	155	182	209	260	309	358
19	23	67	41	44	90	160	17	24	32	40	76	112	136	160	188	217	270	321	373
19	25	74	44	48	98	174	17	26	34	43	80	118	144	170	201	232	290	346	402
20	25	74	46	50	102	183	18	26	35	44	82	122	149	176	208	240	299	358	416
20	26	77	48	52	106	191	18	27	36	45	84	125	153	181	215	248	310	370	431
21	26	77	51	55	114	200	19	28	37	47	89	132	163	193	229	264	330	395	459
22	27	101	55	60	126	219	20	29	39	50	96	144	177	210	249	288	361	432	503
23	26	109	57	62	128	226	20	30	40	51	95	143	177	211	250	289	363	435	507
22	30	109	65	71	135	240	21	31	42	53	107	160	197	233	277	320	401	480	559
25	28	109	65	71	149	257	21	32	43	55	108	163	202	241	287	332	417	500	584
25	31	122	72	78	166	284	23	35	47	60	114	174	218	261	312	362	456	548	641
25	34	134	79	86	184	312	24	37	50	64	120	185	233	281	336	391	494	596	698
28	34	166	88	96	209	349	26	40	55	70	135	207	262	317	379	441	559	674	789
28	38	187	99	107	236	390	28	44	60	77	143	224	286	347	417	486	617	746	875
29	40	198	108	117	255	425	29	46	63	81	151	237	304	370	445	519	661	800	939
31	41	203	118	128	281	466	31	49	67	87	163	256	330	403	485	566	721	874	1027
32	45	224	134	145	317	528	33	53	74	95	175	280	362	445	536	627	801	973	1144
35	46	229	149	162	360	590	36	58	80	104	195	311	405	499	602	705	901	1095	1290
37	50	250	172	186	416	678	39	64	90	116	216	349	457	565	683	801	1027	1251	1474
38	55	276	194	211	485	766	43	72	101	131	241	393	519	645	782	918	1180	1440	1700
43	58	291	231	251	585	914	49	82	116	151	280	461	613	764	928	1091	1406	1718	2030
45	65	328	271	295	680	1073	54	93	131	171	311	518	694	869	1057	1246	1609	1970	2331

Example of weight calculation:

- 1.Total Weight of Cooling Coil Section = Cooling Section Cabinet Weight + Coils Weight
- 2.Total Weight of Fan Section = Fan Section Cabinet Weight + Fan Weight + Motor Weight + Motor Accessories Weight + Fan and Motor Base Frame Weight
- 3.Total Unit Weight = Sum of Weight for each Section + Panel Weight

# Applications

Horizontal Combination 1:

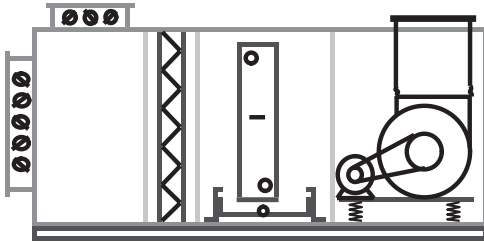

Mixing + Panel Filter + Cooling Coil + Fan

Horizontal Combination 2:

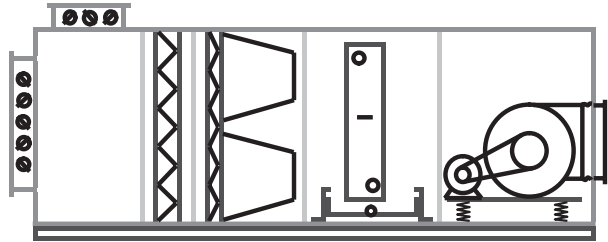

Mixing + Panel Filter + Bag Filter + Cooling Coil + Fan

Horizontal Combination 3:

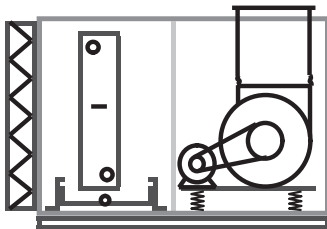

Exposed Filter + Cooling Coil + Fan

Horizontal Combination 4:

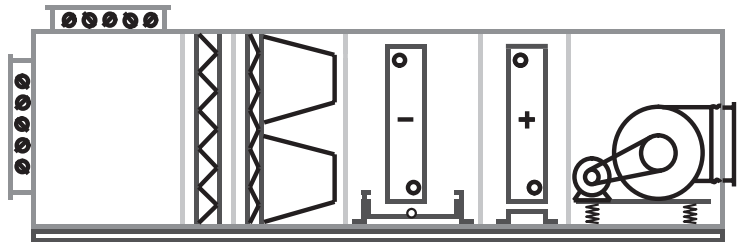

Mixing + Panel Filter + Bag Filter + Cooling Coil + Heating Coil + Fan

Horizontal Combination 5:

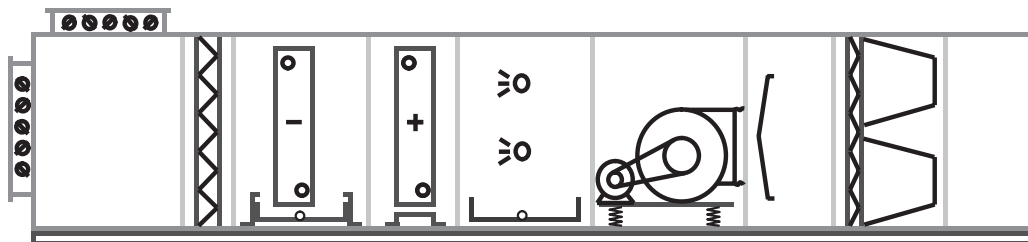

Mixing + Panel Filter + Cooling Coil + Heating Coil + Humidifier + Fan + Diffusion + Bag Filter + Air Supply

Vertical Combination 1:

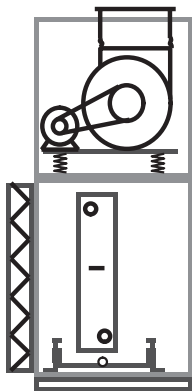

Exposed Filter + Cooling Coil + Fan

Vertical Combination 2:

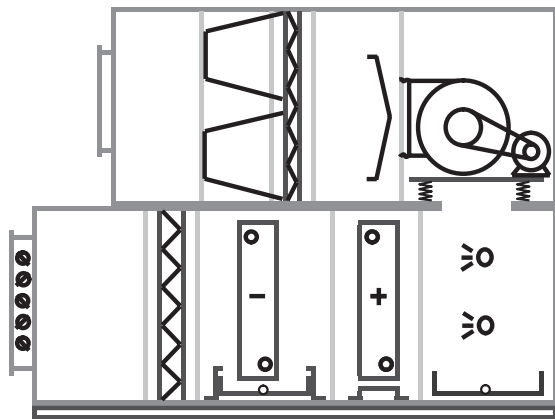

Mixing + Panel Filter + Cooling Coil + Heating Coil + Humidifier + Fan + Diffusion + Bag Filter + Air Supply

# Installation

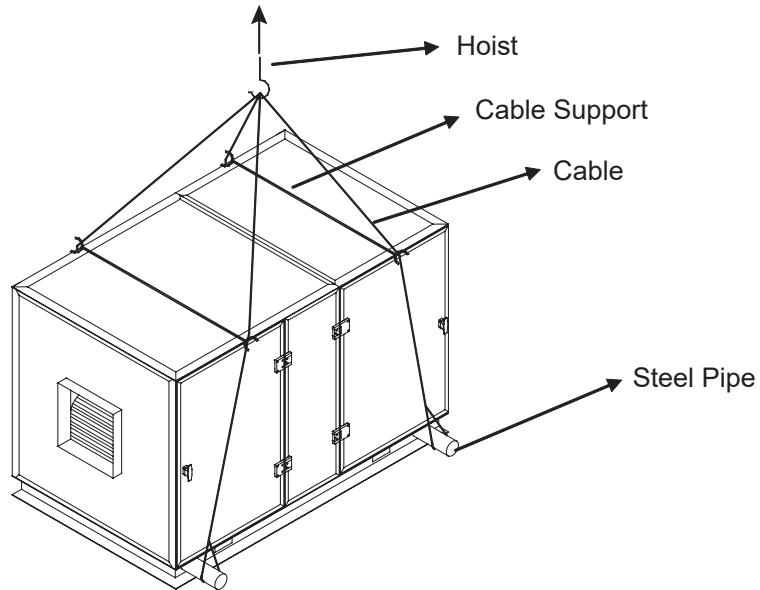

The installation must be done by certified installer. Take note of the following:

- 1) Strictly comply with the installation instructions provided.
- 2) Leave enough space for repair and maintenance.
- 3) Use flexible duct for section of duct connection between the unit and external air duct to avoid vibration transmission.
- 4) The panels must be fitted tightly. Rubber gasket must be compressed properly to avoid air leakage.
- 5) Air filter should be the last item to be installed.
- 6) Proper cleaning must be carried out to clean the interior of the unit to remove debris of installation before commissioning.

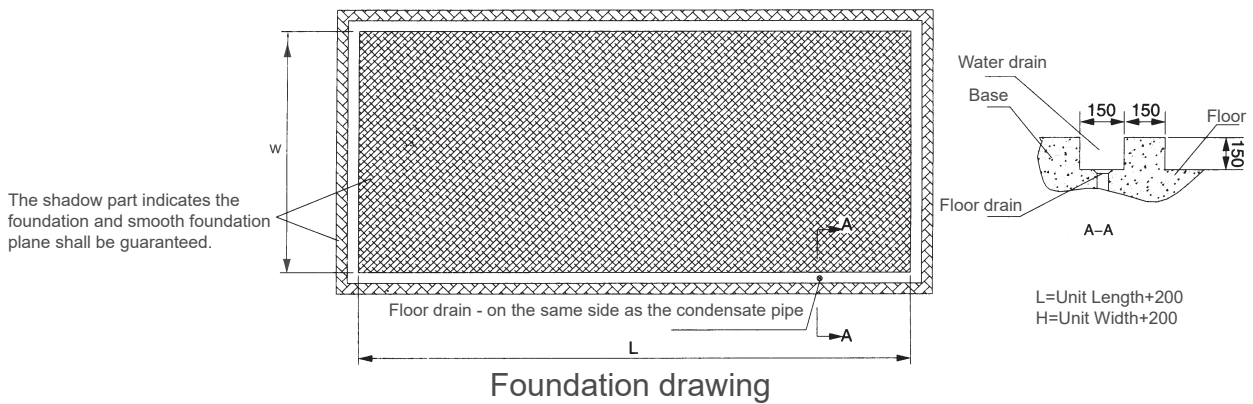

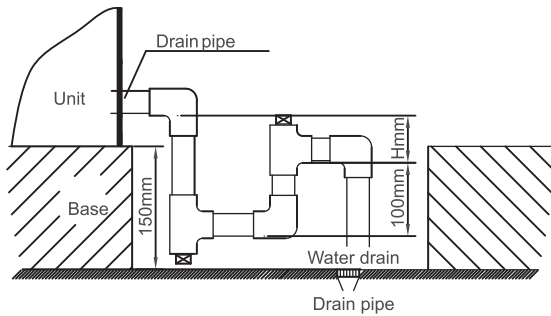

$H = \text{Unit inside static pressure (mmH}_2\text{O)} + 20$   
 The base height should be increased ,  
 when internal negative pressure exceeds 750Pa.

### U Type Water Seal Installation

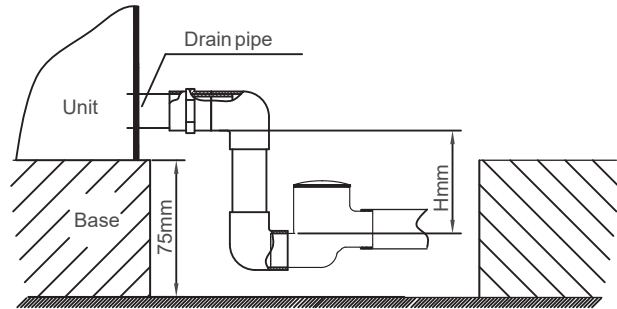

$H = \text{Unit inside static pressure (mmH}_2\text{O)} + 20$   
 The base height should be increased ,  
 when internal negative pressure exceeds 750Pa.

### Ball Type Water Seal Installation

- ◆ Air conditioning units in all structure forms shall be installed on a horizontal foundation.
- ◆ Sufficient space shall be reserved around the unit, especially on the unit piping side and on the access door side of the fan and the motor to conduct the daily inspection and regular maintenance of the unit.
- ◆ One U-shape drain pipe must be connected at the condensate outlet or the floating ball water seal must be set at the condensate outlet before the outlet is connected with external pipes.
- ◆ During the connecting with the inlet and outlet pipes of the coil, the force shall be balanced and no excessive force shall be exerted to prevent the coil from damage.
- ◆ The motor in the air conditioning unit shall be connected to the power supply which is provided with the overload protection and it shall be set with the grounding protection.
- ◆ The air conditioning unit and the external duct shall be in flexible connection to prevent vibration transmission.

## Precautions For Installation And Use

1. The air conditioning unit shall not operate in corrosive gas environment, for instance, acid, alkali, salt mist, etc. Otherwise, it may lead to the damage to the unit enclosure, pipeline or electrical elements.
2. The space around the unit shall be kept clean, dry and well-ventilated. In case the heat exchanger on the air side can be cleaned regularly (at the interval of 1~2 months), its good heat transfer effect can be maintained and the energy can be saved.
3. The drain pipe must be laid according to the requirements in the Instruction to ensure smooth water drainage and proper measures for thermal insulation shall be taken to prevent the generation of condensate. The drain pipe must be inspected before the unit operates. In case of blockage, foreign matters must be eliminated to ensure smooth drainage of the condensate.
4. The wiring of the power supply and the electrical system for the unit shall be inspected frequently to confirm whether the wiring is firm, whether electrical elements operate abnormally. In case of abnormalities, the repair and replacement shall be performed in time and the regular inspection shall be conducted to confirm whether the grounding is reliable.



5. The minimum startup voltage of the unit must be kept above 90% of the rated voltage, the voltage during operation must be within  $\pm 10\%$  of the rated voltage and the voltage difference among all phases shall be within  $\pm 2\%$ . Overvoltage or undervoltage will have adverse effect on the unit. Stable power supply shall be guaranteed and in case of unstable voltage, excessive current will be generated at the moment of unit startup for operation, and this may damage the unit motor.

6. The unit maintenance and repair can only be conducted provided that the unit is shut down and it is disconnected with the power supply.

7. In case of unit failure, it can only be started after causes for the failure are identified and eliminated and no forced startup shall be conducted before the failure is not eliminated.

8. No short connection of the lines for the unit protection device shall be conducted. Otherwise, this may lead to the unit failure.

9. The internal cables of the unit shall be protected properly to prevent the insulation layer from damage due to sharp objects.

10. The wire and cable shall be kept far away from the heat source and they shall not be bent or twisted fiercely.

11. Installation and use of control cabinet:

- 1) There is strong alternating current in the control cabinet and the operation shall be conducted with caution.
- 2) The unit control line shall be separated from the power line to prevent interference.
- 3) The power supply conforming to specified requirements must be used and nonconforming power supply may damage the control cabinet.
- 4) The cable or wire shall not be laid at will in the control cabinet and long exposed conductor shall not be stored in the control cabinet, and the door of the control cabinet shall be installed in position after the overhaul to prevent the rainwater from entering into the cabinet.
- 5) The operation status of the air conditioning unit must be controlled through the control cabinet. It is strictly forbidden to pull or insert the power plugs to start up or shut down the unit and the unit shall not be shut down with the emergency shutdown switch.
- 6) During use, the display shall neither be operated nor controlled with sharp objects and no excessive force shall be exerted to prevent the damage to the display.
- 7) The surface of the controller display shall not be wiped with the solution or strong chemicals. In case of slight dust, it can be cleared away with clean and soft cloth or cotton yarn; in case of much dirt on the surface, it shall be eliminated with clean and soft cloth or cotton yarn and then the surface can be dried naturally.
- 8) In case of failure alarming or failure indication in the control cabinet, users shall not repair the unit by themselves; they shall contact TICA Air-Conditioning Co., Ltd. through the service phone or contact local service agent of TICA Air-Conditioning Co., Ltd.

12. Air filter

The accumulated dust of the unit strainer shall be inspected regularly (twice for each month as recommended). Users who have installed differential pressure detector shall clean or replace the filter in case the final resistance reaches the specified value and TICA suggests that the final resistance value shall be:

Specification of filtration efficiency	Suggested final resistance (Pa)
G3	100-200
G4	150-250
M5-M6	250-300
F7-F8	300-400
F9-H11	400-500
HEPA	400-600

### 3. Heat exchanger

The coil fin, copper pipes, etc. of the heat exchanger shall be free from scratch or flattening due to impact. The coil shall be kept clean and the coil fin can be brushed and washed with the nylon brush. It shall be cleaned with the vacuum cleaner before brushing. In case of the compressed air, the coil may be cleaned with the high-pressure air pipe or nozzle. Upon the cleaning of the coil, its external surface shall be free from dust and the heat transfer effect of the internal surface shall reach its initial updating and heat transfer capacity. Besides the fin cleaning, internal incrustation shall be washed and removed from the coil after the coil has been used for 2~3 years. The cold water and hot water for the unit coil shall be softened water.

### 14. Drain pipe

The drain pipe must be inspected before the unit operates. In case of blockage, foreign matters must be eliminated to ensure smooth drainage of the condensate.

15. The belt tightness shall be readjusted after the unit has operated for one week and the regular inspection shall be conducted every three months of operation in future.

16. The wiring pile head of the wire will be loosened after the unit operates for a certain time. It shall be inspected and tightened on the third day upon the first startup.

17. Bearings for the fan and the motor shall be inspected regularly (three times per month as recommended). The seal ring of the motor bearing (for instance, V-seal ring) shall be inspected, and it shall be replaced timely if necessary; the erection joint shall be inspected to confirm whether it is loose; the bearing operation shall be inspected through monitoring the abnormal noise, vibration, oil consumption or with the bearing vibration measurement element, etc. In case of any abnormalities, the unit shall be shut down immediately, and causes shall be identified and eliminated timely. Heating shall be conducted or special tools shall be used for the assembly and disassembly of bearings and bearings shall not be knocked violently or moved.

### 18. Servicing of fan bearing:

For fans with the oil nozzle, the lubricating oil of matching specification shall be filled into the bearing regularly.

In case that the users select the grease of the same designation for grease filling, they shall use the grease of the designation all the time.

The validity of the lubricating grease depends on the grease type, revolving speed of bearings, bearing diameter and operating environment. Under normal conditions, the lubricating grease shall be replaced after the fan has operated for about 1,500 h; in case that the fan keeps 24-hour operation, the lubricating grease shall be replaced upon 500~700-hour operation.

Methods for lubricating oil filling: the bearing shall keep rotating during the grease filling, and in case that a layer of fresh grease overflow from the dust cover, the grease filling may be stopped and the wind wheel shall be rotated quickly manually to discharge excessive grease.

19. The steam valve of the steam coil must be closed before the fan stops operation and the steam valve of the steam humidifier must be closed before the fan stops operation;

20. In case that the customers provide the electrical cabinet by themselves, they must ensure the electric heater is started upon the startup of the fan and the electric heater shall be shut down 5 min before the fan stops operation and the overheating protection switch of the electric heater shall be connected to the protection loop of the electric heater.

## Maintenance And Service

The air conditioning unit is an equipment and users are suggested to record the daily operation data of the equipment and to conduct regular maintenance and service.

1. The following inspections shall be conducted properly before the use of the equipment:

- ◆ The power supply wiring of all indoor end equipment shall be inspected to confirm whether there is wrong wiring and whether the fan rotation is normal.
- ◆ The inspection shall be conducted to confirm whether all air valves at the inlet and outlet of the indoor end equipment are open.
- ◆ The inspection shall be conducted to confirm whether all power supply lines and control lines are connected in position and whether the wiring is correct according to the wiring diagram, whether the grounding is reliable and whether all connection terminals are secure.

2. Daily maintenance during the equipment use:

Unit maintenance contents	Standard service cycle			Remarks
	Monthly	Quarterly	Half a year	
1. The inspection shall be inspected to confirm whether the power line (from the distribution cabinet to the unit) is loose or damaged.			★	
2. The inspection shall be conducted to confirm whether the condensate discharge is normal		★	●	Is the installation conducted according to the pipe connection diagram? Is it dirty or blocked? Is the drainage smooth? Is there any overflow, etc. due to this?
3. The inspection shall be conducted to confirm whether there is abnormal noise during the operation of the unit.	★		●	For instance, sharp metal friction sound, whistlers, obvious clash or resonance, significant electromagnetic noise (disgusting) and other abnormal noise.
4. The inspection shall be conducted to confirm whether it is necessary to clean the air side of heat exchanger (surface dust, sundries, etc.)		★	●	Spaces among fins are full of dust and there are sundries attached on the inlet side of the coil, etc.
5. The inspection shall be conducted to confirm whether the air strainer is dirty or blocked and whether it is necessary to clean or replace the strainer.	★	●		The differential pressure alarm value and the scale value in the differential pressure gauge reach the final resistance value, etc.

Special reminder: The daily maintenance cannot replace the implementation of specific requirements in precautions for installation and use of the Warranty and Maintenance Manual. During the daily maintenance, precautions for installation and use must be implemented strictly at the same time so as to ensure the normal operation and use of the product.

3. We recommend the following maintenance and service methods for the equipment which is not used for a long time

- ◆ In case that the unit does not operate for a long time or does not operate in winter, the power must be turned off and the water shall be discharged from the water system and the steam coil of the unit.
- ◆ If necessary, the maintenance and service may be conducted according to the pre-use maintenance and service methods of the equipment.

Note:

1. User service: mandatory inspection —●, recommended inspection —★
2. Vulnerable parts required for the service shall be purchased from TICA Air-Conditioning Co., Ltd.
3. The service methods apply to the cycle during normal use and the arrangement shall be made based on actual conditions in case of use in bad conditions.









TICA participates in the ECC programme for AHU. Check ongoing validity of certificate: [www.eurovent-certification.com](http://www.eurovent-certification.com) or [www.certiflash.com](http://www.certiflash.com) 



Follow the Official Site of  
«TICA SNG» LLC  
[www.tica.pro](http://www.tica.pro)

---

«TICA SNG» LLC

tel: +7 495 127 79 00, +7 915 650 85 85

e-mail: [info@tica.pro](mailto:info@tica.pro)

[www.tica.pro](http://www.tica.pro)

---

Note: Due to constant improvement and innovation of TICA's products, the product models, specifications and parameters contained in this document are subject to change without prior notice.